

LED Natural Sunlight (with DC Input Voltage)

GL-LMR50-12-24V-NL

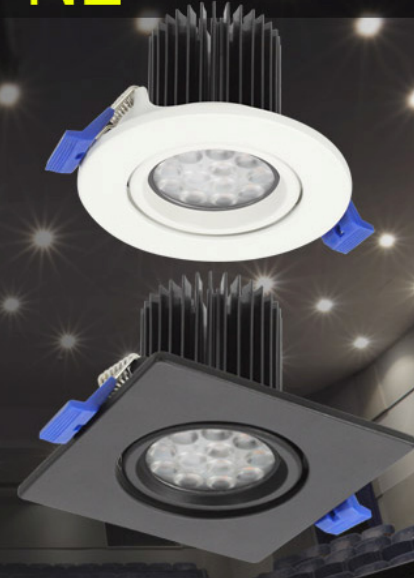

24V
DC
INPUT

Features

- High CRI is 97.
- High CQS is 97.
- TM-30-15 Rf is up to 95.
- TM-30-15 Rg is up to 103.
- DC 24V input voltage and polarity insensitive.
- 30° and 40° beam angle available.
- Can be dimmable with given the appropriate DC electrical signal (typ. PWM).
- Optional round and square housing accessories in black and white colors.
- Optional single, double and triple housing accessories.
- Mistake-proofing design for user friendly.
- Expandable design of installation lighting fixtures.

CE FC IP66



Specifications

Model No.	GL-LMR50-12-24V-NL-WW
Energy Used	11 W
Rated Life	30,000 Hours
Input Voltage	DC 24V / +7% , -10%
CCT (color)	3000K
Luminous Flux	640 lm
System Efficacy	58 lm/W
CRI (Typ.)	97
CQS (Typ.)	97
TM-30-15 Rf (Typ.)	95
TM-30-15 Rg (Typ.)	103
Beam Angle	30° / 40°
Dimension	∅ 50 x 60mm
IP Rating	IP20
Operation Temperature	-20°C ~ +40°C
Net Weight	92 g
Package	25 PCS / Carton

Outline / Dimension

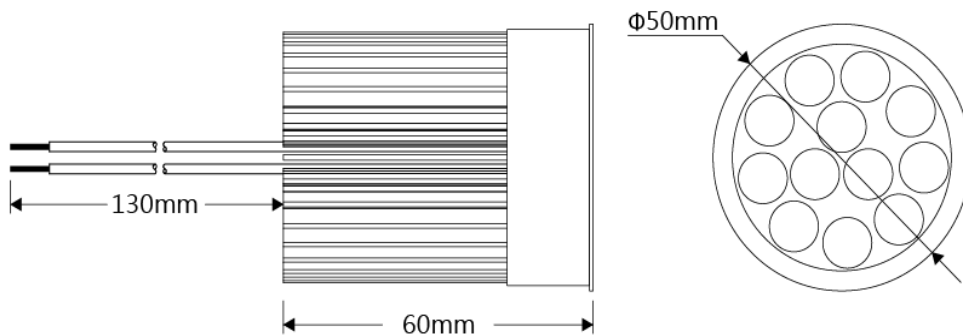

Luminous Intensity Distribution Diagram

GL-LMR50-12-24V-NL-WW-3000K-30D

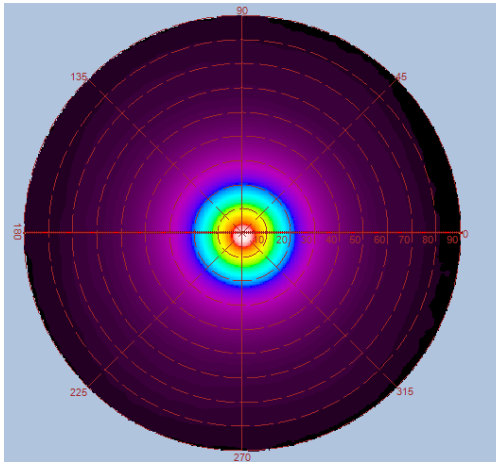

光强度(Candela)

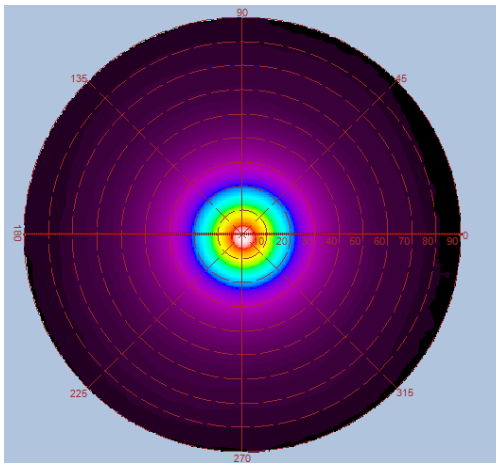
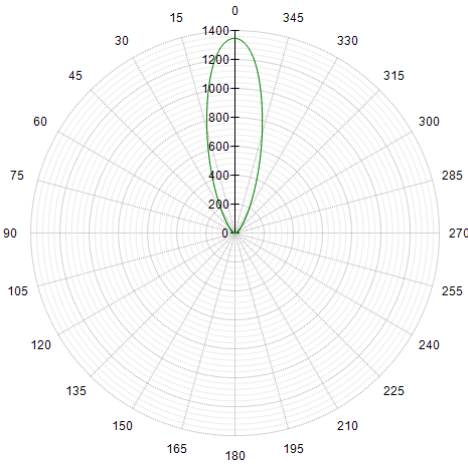

光强度(Candela)

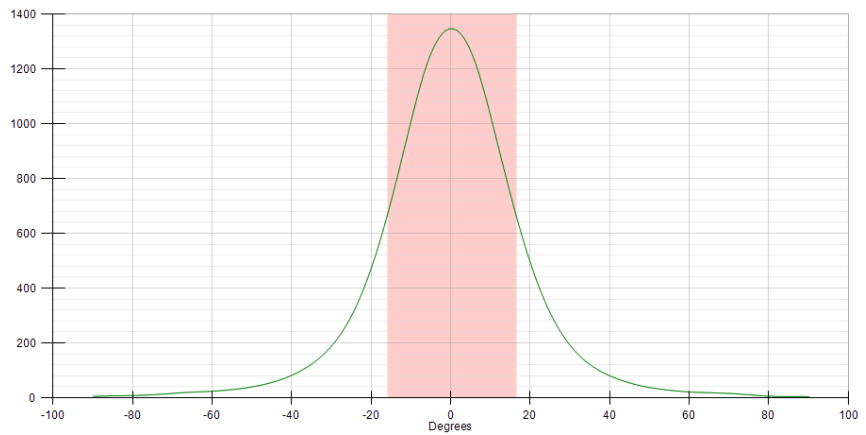

Height	E Avg.	E Max.	Diameter
1.0M	1283 Lx	1644 Lx	54 cm
2.0M	309 Lx	390 Lx	107 cm
3.0M	136 Lx	170 Lx	161 cm
4.0M	76 Lx	96 Lx	214 cm
5.0M	48 Lx	61 Lx	268 cm

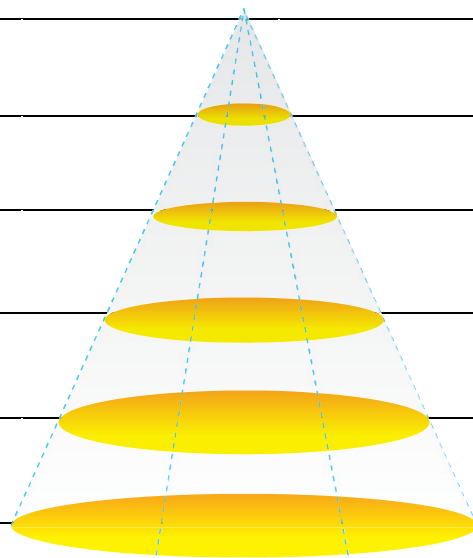

GL-LMR50-12-24V-NL-WW-3000K-40D

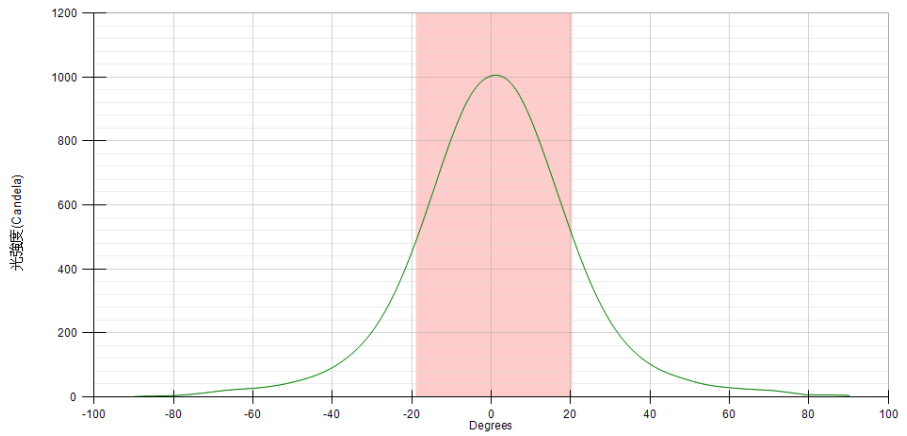
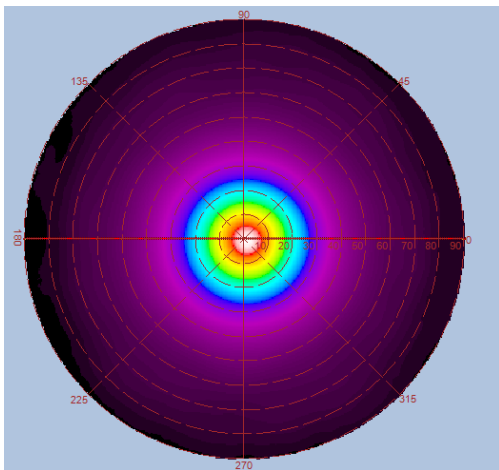
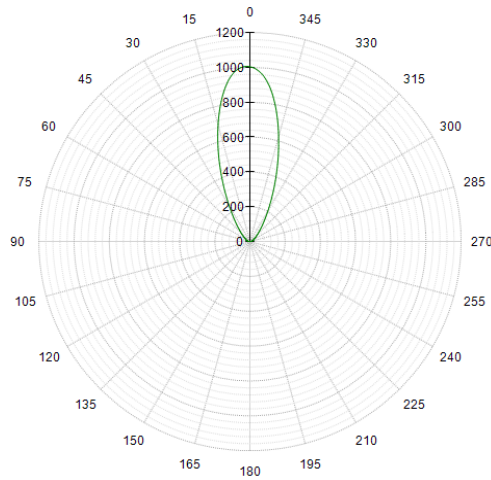
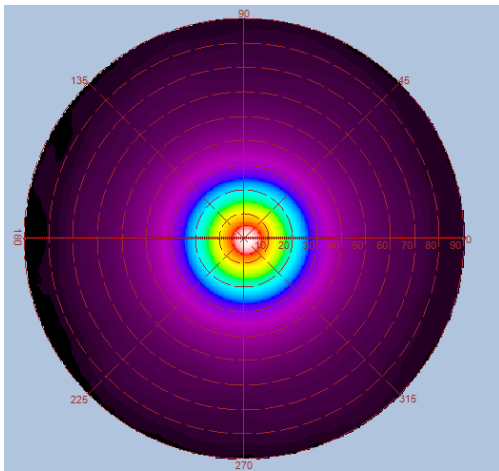

Height	E Avg.	E Max.	Diameter
1.0M	806 Lx	1098 Lx	73 cm
2.0M	194 Lx	262 Lx	146 cm
3.0M	85 Lx	114 Lx	218 cm
4.0M	48 Lx	64 Lx	291 cm
5.0M	30 Lx	41 Lx	364 cm

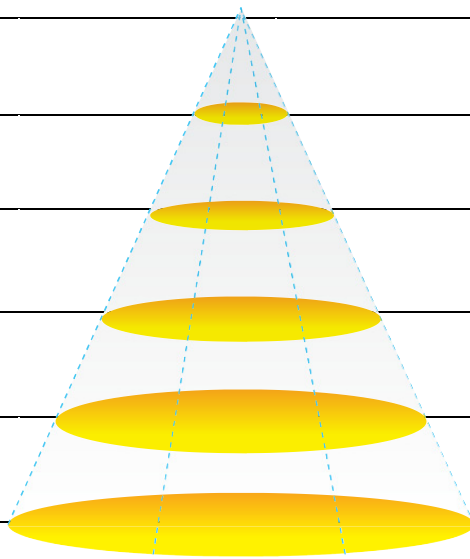

Spectroradiometric Parameters

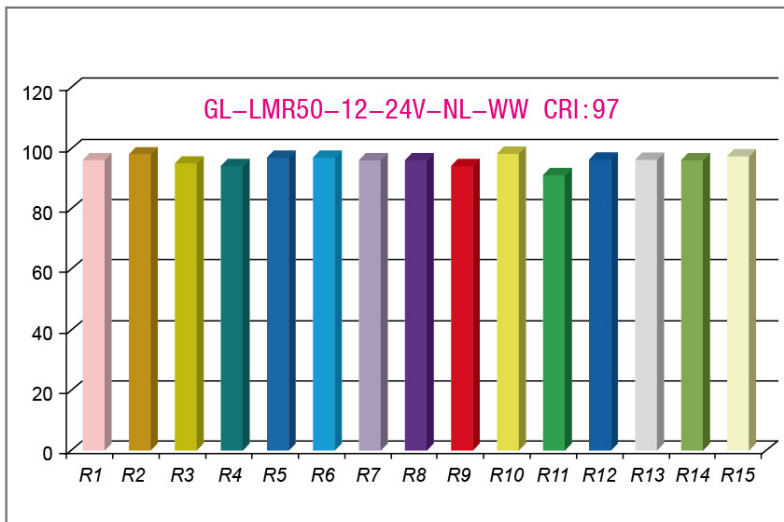
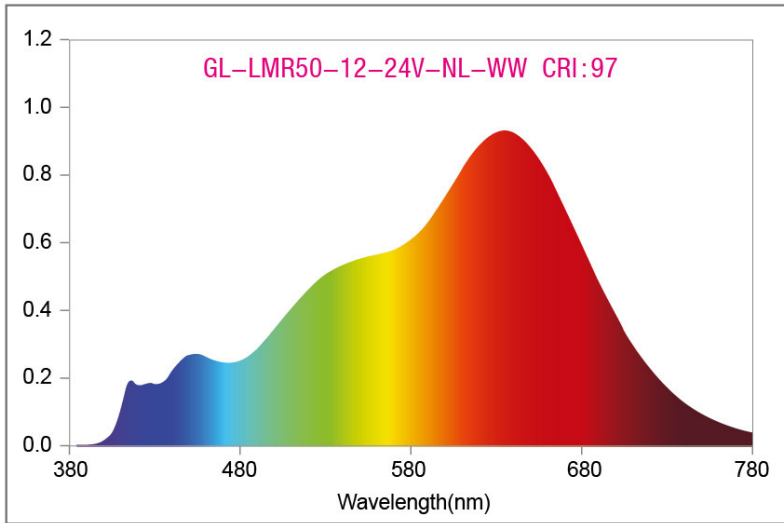

Application

Non-Dimmable

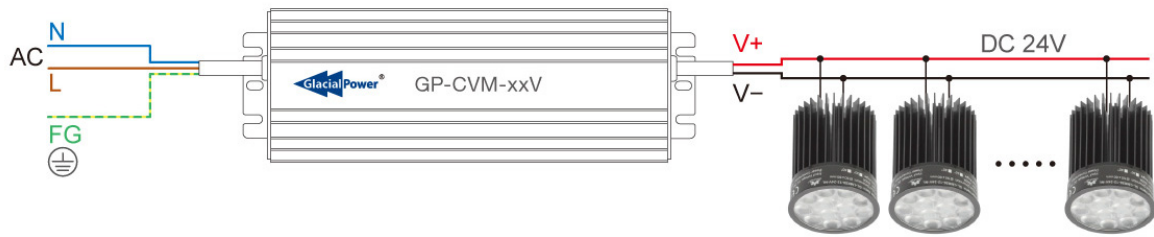

AC-TRIAC Dimmable

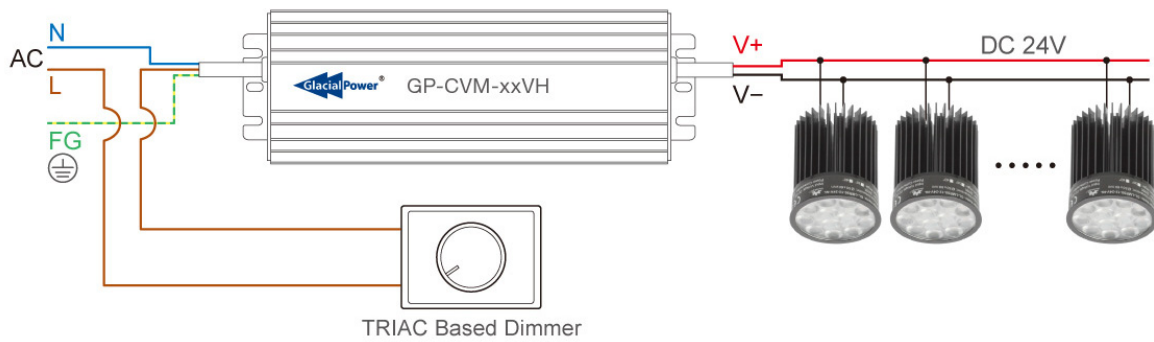

3-in-1 Dimmable

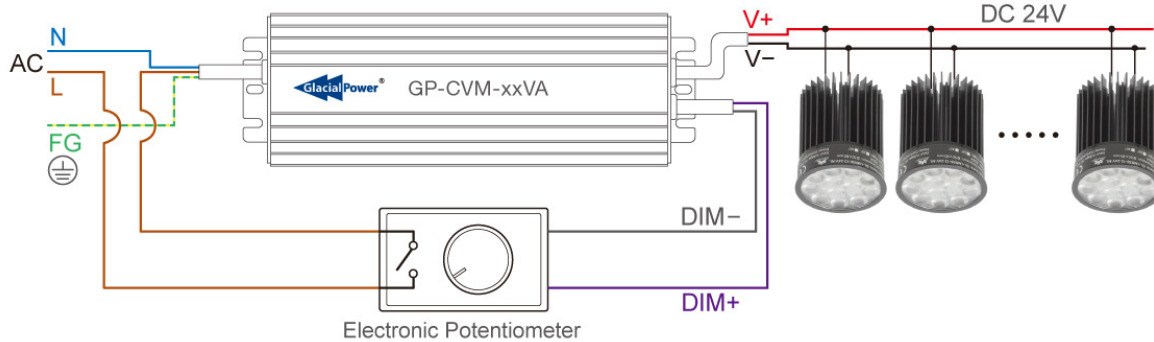

DALI Dimmable

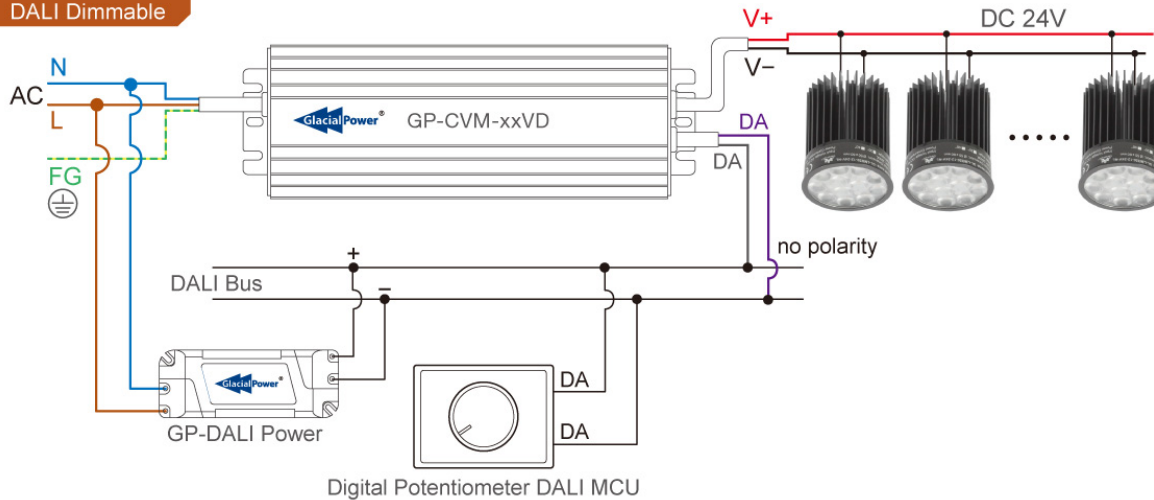

GL-LMR50 application with Solar & Battery

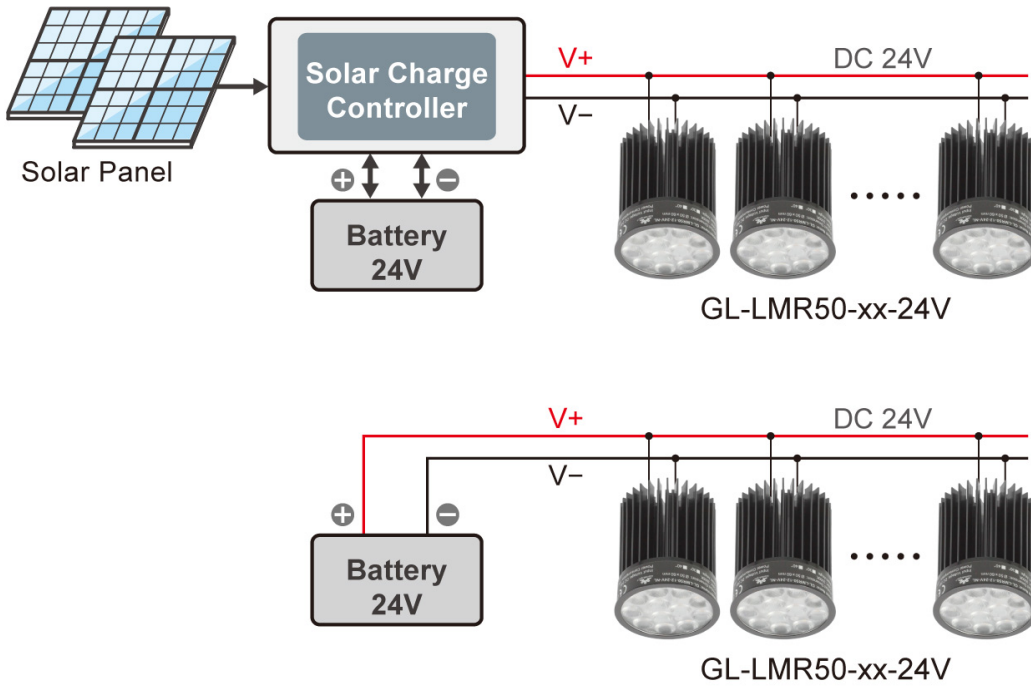

Accessory

Type	Single fixture (for 1 lamp)	Single fixture (for 1 lamp)
Part No.	CE-R5XXI000WS0001	CE-R5XXI000AS0001
External Dimensions	Φ90 mm x 29mm(H)	
Shape	Round	
Fixture Hole	Φ75 mm	
Compatible With	GL-LMR50-XX-24V-NL Series	
Materials/ Color	Aluminum / White	Aluminum / Black
Net Weight	70 g	
Packing	1 PCS / carton	
Photograph		

Accessory

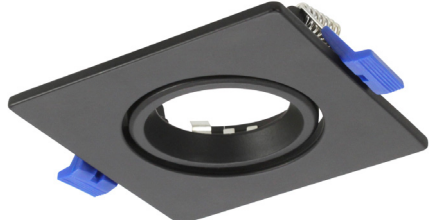
Type	Single fixture (for 1 lamp)	Single fixture (for 1 lamp)
Part No.	CE-R5XXI000WS1001	CE-R5XXI000AS1001
External Dimensions	90 mm x 90mm x 29mm(H)	
Shape	Square	
Fixture Hole	Φ75 mm	
Compatible With	GL-LMR50-XX-24V-NL Series	
Materials/ Color	Aluminum / White	Aluminum / Black
Net Weight	80 g	
Packing	1 PCS / carton	
Photograph		

Type	Double fixture (for 2 lamps)	Triple fixture (for 3 lamps)
Part No.	CE-R5XXI000WS1011	CE-R5XXI000WS1021
External Dimensions	185 mm x 95mm x 29mm(H)	270 mm x 95mm x 29mm(H)
Shape	Rectangle	
Fixture Hole	165 mm x 75mm	250 mm x 75mm
Compatible With	GL-LMR50-XX-24V-NL Series	
Materials/ Color	Aluminum / White	
Net Weight	200 g	300 g
Packing	1 PCS / carton	
Photograph		

